

L-PRO2S Amplifier Module Data Sheet

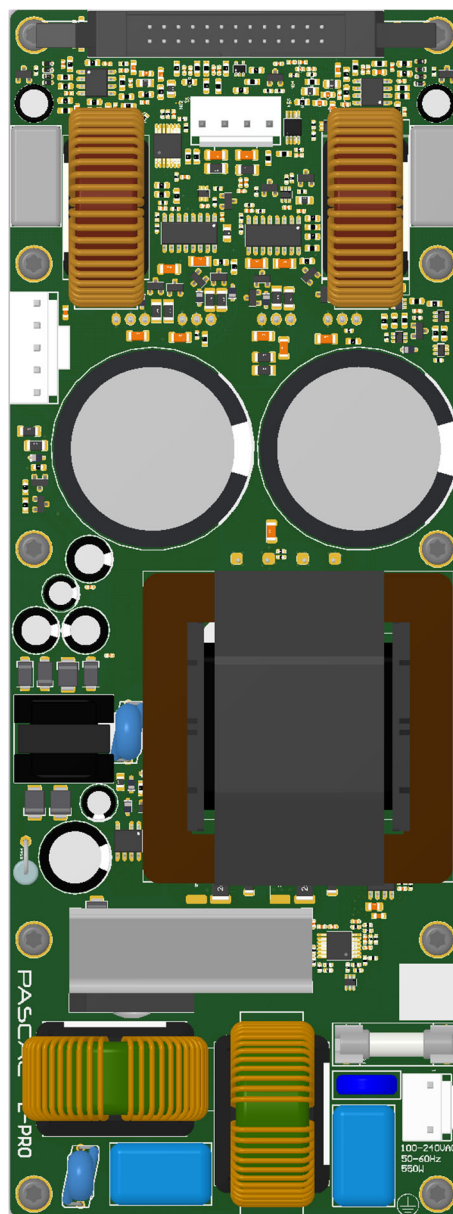

L-PRO2S Amplifier Module

Table of Contents

1	Features and description	3
2	General specifications	4
2.1	Audio specifications	4
2.2	Input & output loading	5
2.3	Audio input interfacing.....	5
2.4	AC Mains & thermal specification.....	6
2.5	Auxiliary power supply specification	7
3	Audio measurements	8
3.1	Frequency response Ch1 and Ch2 (SE)	8
3.2	Frequency response Ch1 - Ch2 (BTL).....	9
3.3	Total Harmonic Distortion + Noise (THD+N) Ch1 and Ch2 (SE).....	10
3.4	Total Harmonic Distortion + Noise (THD+N) Ch1 - Ch2 (BTL)	11
3.5	Noise spectrum	11
3.6	Intermodulation Distortion (CCIF, TIM) Ch1 and Ch2 (SE).....	12
3.7	Intermodulation Distortion (CCIF, TIM) Ch1 - Ch2 (BTL).....	12
3.8	Output resistance & cross talk	13
3.9	Output voltage vs. frequency.....	14
3.10	Efficiency	15
4	Control and readout specification	16
4.1	Control pins.....	16
4.2	Readout pins	17
5	Protection features	18
5.1	L-PRO2S functional blocks.....	19
5.2	L-PRO2S Single Ended (SE) 2 channel 2 - 8 Ohm amplifier	20
5.3	L-PRO2S Bridge Tied Load (BTL) 4 - 8 Ohm amplifier.....	21
5.4	L-PRO2S Bridge Tied Load (BTL) 100/70V Line amplifier	22
6	L-PRO2S connections	23
6.1	Mains Power connector	24
6.2	Signal and Control connector	24
6.3	Speaker Output connector	25
6.4	DC-Supply connector.....	25
7	Mechanical specifications	26
8	Regulatory compliance	27
8.1	Safety compliance.....	27
8.2	Electro Magnetic Compliance	28
8.3	ESD precautions.....	28
8.4	Changes.....	28
8.5	CE marking.....	28

1 Features and description

Features

- 810 W + 810 W (SE) or 1500 W (BTL/100V) amplifier channel(s) using Pascal's UMAC™ technology for unmatched sonic performance.
- Universal mains regulated power supply with PFC using Pascal's UREC™ power supply technology
- Auxiliary power supply for external circuitry like DSP Front End solutions
- Ecodesign (ErP) & Energy Star compliant standby consumption of < 0.5W
- Wake on Music ready with selectable timing
- Full protection scheme
- Ultra-compact size
- Unmatched total system efficiency
- Multiple readouts (temperature, amplifier output voltage, clip monitor, amplifier protect/mute, VAC)
- Safety approved and verified for EMC compliance

Product summary

Parameter	Typical Value
Total Output power (1% THD+N, 1kHz @ 4Ω)	810 W + 810 W
BTL power @ 8Ω	1500 W
Dynamic BTL power @ 4Ω	2500 W*
Total system efficiency (SE, 2x400 W @ 8Ω)	89.5 %
Peak output current (Ch1)	40 A
(Ch2)	40 A
THD+N (1kHz @ 1W)	0.003 %
Dynamic range	120 dB(A)
Idle noise	54 μV(A)
Output resistance (1kHz)	6.5 mΩ
Mains input voltage	85V _{AC} - 265V _{AC}
Standby consumption	0.23 W
SMPS power	1500 W

* Output voltage of 160 V peak, yielding a dynamic headroom of more than 2 dB and a peak SPL rating equivalent to a conventional 2500 W amplifier

Description

The L-PRO2S module is a Class-D amplifier with integrated universal mains power supply with PFC.

The L-PRO2S is a symmetric 2 channel amplifier with identical high-power channels suitable for a wide product range from professional audio solutions to 100/70V constant voltage systems.

The L-PRO2S offers an ultra-compact size with an unmatched total system efficiency to ease the integration of the modules into any audio solution.

In addition, the L-PRO2S module offers several readouts and controls, allowing external DSP control of the modules. The built-in auxiliary power supply makes it easy to supply a DSP Front End.

Typical applications

- Professional Audio Solutions
- Self-Powered Loudspeakers
- Installation Systems
- 100/70V Systems

2 General specifications

2.1 Audio specifications

Electrical Characteristics @ $T_a = 25^\circ\text{C}$ (unless otherwise specified)

Symbol	Parameter	Conditions	Min	Typ	Max	Unit
$V_{out,max}$	Peak output voltage Ch1 & Ch2	Unloaded	-	± 84.5	-	V
$I_{out,peak}$	Peak output current		-	40	-	A
$P_{o,tot}$	Total module output power ¹	230V _{AC} 120V _{AC} 100V _{AC}	-	1500 1500 1300	-	W
P_o	Output power @ 1% THD+N, 1kHz ² Ch1 or Ch2, single channel driven $R_L=8\Omega$	230V _{AC} 120V _{AC}	-	410 410	-	W
P_o	Output power @ 1% THD+N, 1kHz ² Ch1 or Ch2, single channel driven $R_L=4\Omega$	230V _{AC} 120V _{AC}	-	810 810	-	W
P_o	Output power @ 1% THD+N, 1kHz ² Ch1 or Ch2, single channel driven $R_L=2.7\Omega$	230V _{AC} 120V _{AC}	-	1200 1200	-	W
P_o	Output power @ 1% THD+N, 1kHz ² Ch1 or Ch2, single channel driven $R_L=2\Omega$	230V _{AC} 120V _{AC}	-	900 ⁴ 900 ⁴	-	W
P_o	Output power @ 1% THD+N, 1kHz ² Ch1 and Ch2, Bridge tied load $R_L=6.67\Omega$	230V _{AC} 120V _{AC} 100V _{AC}	-	1500 1500 1300	-	W
P_o	Output power @ 1% THD+N, 1kHz ² Ch1 and Ch2, Bridge tied load $R_L=4\Omega$	230V _{AC} 120V _{AC}	-	1400 1400	-	W
THD+N	THD+N @ 1W, 1kHz, $R_L = 8\Omega^2$			0.0028		%
$V_{noise SE}$	Output idle noise	Unweighted A-weighted	-	73 54	-	μV_{RMS}
$V_{noise BTL}$	Output idle noise	Unweighted A-weighted	-	96 75	-	μV_{RMS}
DR _{SE}	Dynamic Range	Unweighted A-weighted	-	118 120	-	dB
DR _{BTL}	Dynamic Range	Unweighted A-weighted	-	121.4 123.6	-	dB
A	Voltage gain @ 1kHz, Ch1 & Ch2	SE	-	27.6	-	dB
$A_{var SE}$	Frequency response variance Ch1 or Ch2 @ 20Hz - 20kHz	Open Load 8 Ω 4 Ω 2 Ω	-	0.1 0.1 0.33 0.6	-	dB
$A_{var BTL}$	Frequency response variance Ch1 and Ch2 @ 20Hz - 20kHz	Open Load 6.67 Ω 4 Ω	-	0.1 0.3 0.6	-	dB
BW _{up SE}	Upper bandwidth @ -3dB Ch1 or Ch2	Open Load 8 Ω 4 Ω 2 Ω	-	110 85 75 55	-	kHz
BW _{up BTL}	Upper bandwidth @ -3dB Ch1 and Ch2	Open Load 6.67 Ω 4 Ω	-	110 65 50	-	kHz
BW _{low}	Lower bandwidth @ -3dB Ch1 & Ch2	All loads	-	1.6	-	Hz
R_{out}	Output resistance ³ Ch1 or Ch2	1 kHz 20 kHz	-	6.5 120	-	m Ω
$V_{out,offset}$	Amplifier output DC Offset Ch1 or Ch2	8 Ω	-	± 1	-	mV
IMD _{CCIF SE}	Intermodulation distortion (CCIF), Ch1 or Ch2	18kHz & 19kHz $P_o = 10W, 8\Omega$	-	0.0008	-	%
IMD _{TIM SE}	Transient Intermodulation distortion (TIM), Ch1 or Ch2	$P_o = 10W, 8\Omega$	-	0.002	-	%
IMD _{CCIF BLT}	Intermodulation distortion (CCIF), Ch1 and Ch2	18kHz & 19kHz $P_o = 10W, 6.67\Omega$	-	0.0004	-	%
IMD _{TIM BLT}	Transient Intermodulation distortion (TIM), Ch1 and Ch2	$P_o = 10W, 6.67\Omega$	-	0.003	-	%

Table 2-1: Audio specifications

Note 1: Maximum total power limited by the power supply.

Note 2: Measured using the Audio Precision AES-17 filter.

Note 3: Measured using “APx Output Impedance Utility” at the mating part of the output connector, thereby including contact resistance of the connectors.

Note 4: In case sufficient cooling is available, it can be expected that the L-PRO2S module is able to deliver minimum 900W in 2Ω with a Crest Factor of 12dB at 40°C ambient (TA).

2.2 Input & output loading

Electrical Characteristics @ $T_a = 25^\circ\text{C}$ (unless otherwise specified)

Symbol	Parameter	Conditions	Min	Typ	Max	Unit
Z_{INPUT}	Input impedance	Balanced Unbalanced	-	7.2 3.6	-	kΩ
$Z_{\text{L SE}}$	Loudspeaker nominal impedance range Ch1 or Ch2 Single Ended (SE)	Ch1 or Ch2	2 ¹	8	∞	Ω
$Z_{\text{L BTL}}$	Loudspeaker nominal impedance range Ch1 - Ch2 Bridge Tied Load (BTL)	Ch1 - Ch2	4 ¹	8	∞	Ω
$Z_{\text{L C SE}}$	Maximum purely capacitive loading of amplifier output		-	-	1	μF
$Z_{\text{L C BLT}}$	Maximum purely capacitive loading of amplifier output				0.5	μF

Table 2-2: Input and output loading

Note 1: L-PRO2S is fully protected for $Z_L < Z_L \text{ Min}$. Connection of loads $< Z_L \text{ Min}$ is not recommended as a low load impedance in combination with the amplifier current limit will limit maximum output power.

2.3 Audio input interfacing

Electrical Characteristics @ $T_a = 25^\circ\text{C}$ (unless otherwise specified)

Symbol	Parameter	Value	Unit
In+_{max}	Absolute maximum audio input voltage	±20	V_p
In-_{max}	Absolute maximum audio input voltage	±20	V_p
In+ In-	Audio input voltage (In+) - (In-) _{max} for full output voltage swing	±3.5 ¹	V_p

Table 2-3: Audio input voltage rating

Note 1: Internal input stage is supplied from an internal ±5V.

2.4 AC Mains & thermal specification

Electrical Characteristics @ $T_a = 25^\circ\text{C}$ (unless otherwise specified)

Symbol	Parameter	Conditions	Min	Typ	Max	Unit
V _{AC} Range	Operational voltage range	45Hz - 65Hz	85	-	265	V _{AC}
P _{120VAC NS}	Mains power input No signal applied Pascal L-PRO2S I/O-board attached	Standby Mute Idle	-	0.34 5.5 12.1	-	W _{RMS}
P _{230VAC NS}	Mains power input No signal applied Pascal L-PRO2S I/O-board attached	Standby Mute Idle	-	0.36 5.2 13.3	-	W _{RMS}
P _{120VAC NS}	Mains power input No signal applied	Standby Mute Idle	-	0.17 4.0 11.0	-	W _{RMS}
P _{230VAC NS}	Mains power input No signal applied	Standby Mute Idle	-	0.23 3.8 12.3	-	W _{RMS}
P _{AC_PN}	Mains power input 230V _{AC} Both channels driven (SE), Pink Noise $P_{out,RMS} = 2 \times 1/8^{th} 750W (4\Omega) 700W (2\Omega)$	$R_L = 4\Omega$ $R_L = 2\Omega$	-	240 243	-	W _{RMS}
P _{AC_PN}	Mains power input 120V _{AC} Both channels driven (SE), Pink Noise $P_{out,RMS} = 2 \times 1/8^{th} 750W (4\Omega) 700W (2\Omega)$	$R_L = 4\Omega$ $R_L = 2\Omega$	-	246 244	-	W _{RMS}
P _{AC_PN}	Mains power input 100V _{AC} Both channels driven (SE), Pink Noise $P_{out,RMS} = 2 \times 1/8^{th} 750W (4\Omega) 700W (2\Omega)$	$R_L = 4\Omega$ $R_L = 2\Omega$	-	242 248	-	W _{RMS}
P _{AC_PN}	Mains power input 230V _{AC} Both channels driven (BTL), Pink Noise $P_{out,RMS} \text{ ch1 - ch2} = 1/8^{th} 1500W (6.67\Omega) 1400W (4\Omega)$	$R_L = 6.67\Omega^1$ $R_L = 4\Omega$	-	246 243	-	W _{RMS}
P _{AC_PN}	Mains power input 120V _{AC} Both channels driven (BTL), Pink Noise $P_{out,RMS} \text{ ch1 - ch2} = 1/8^{th} 1500W (6.67\Omega) 1400W (4\Omega)$	$R_L = 6.67\Omega^1$ $R_L = 4\Omega$	-	248 244	-	W _{RMS}
P _{AC_PN}	Mains power input 100V _{AC} Both channels driven (BTL), Pink Noise $P_{out,RMS} \text{ ch1 - ch2} = 1/8^{th} 1500W (6.67\Omega) 1400W (4\Omega)$	$R_L = 6.67\Omega^1$ $R_L = 4\Omega$	-	248 248	-	W _{RMS}
P _{Loss}	Module power loss at 230V _{AC} Both channels driven (SE), Pink Noise $P_{out,RMS} = 2 \times 1/8^{th} 750W (4\Omega) 700W (2\Omega)$	$R_L = 4\Omega$ $R_L = 2\Omega$	-	48 67	-	W _{RMS}
P _{Loss}	Module power loss at 120V _{AC} Both channels driven (SE), Pink Noise $P_{out,RMS} = 2 \times 1/8^{th} 750W (4\Omega) 700W (2\Omega)$	$R_L = 4\Omega$ $R_L = 2\Omega$	-	54 69	-	W _{RMS}
P _{Loss}	Module power loss at 100V _{AC} Both channels driven (SE), Pink Noise $P_{out,RMS} = 2 \times 1/8^{th} 750W (4\Omega) 700W (2\Omega)$	$R_L = 4\Omega$ $R_L = 2\Omega$	-	49 69	-	W _{RMS}
P _{Loss}	Module power loss at 230V _{AC} Both channels driven (BTL), Pink Noise $P_{out,RMS} \text{ ch1 - ch2} = 1/8^{th} 1500W (6.67\Omega) 1400W (4\Omega)$	$R_L = 6.67\Omega^1$ $R_L = 4\Omega$	-	57 67	-	W _{RMS}
P _{Loss}	Module power loss at 120V _{AC} Both channels driven (BTL), Pink Noise $P_{out,RMS} \text{ ch1 - ch2} = 1/8^{th} 1500W (6.67\Omega) 1400W (4\Omega)$	$R_L = 6.67\Omega^1$ $R_L = 4\Omega$	-	57 69	-	W _{RMS}
P _{Loss}	Module power loss at 100V _{AC} Both channels driven (BTL), Pink Noise $P_{out,RMS} \text{ ch1 - ch2} = 1/8^{th} 1500W (6.67\Omega) 1400W (4\Omega)$	$R_L = 6.67\Omega^1$ $R_L = 4\Omega$	-	55 69	-	W _{RMS}
$\eta_{tot,SE}$	System efficiency @ $2 \times 8\Omega$ (SE) $P_{out} = 2 \times 400W @ 1kHz$	230V _{AC} 120V _{AC}	-	89.5 87	-	%
$\eta_{tot,BTL}$	System efficiency @ 4Ω (BTL) $P_{out} = 1200W @ 1kHz$	230V _{AC} 120V _{AC}	-	82.3 80.0	-	%
PF _{8Ω}	Power Factor @ $2 \times 8\Omega$ (SE) $P_{out} = 2 \times 400W @ 1kHz$	230V _{AC} 120V _{AC}	-	0.96 0.98	-	
PF _{4Ω}	Power Factor @ 4Ω (BTL) $P_{out} = 1200W @ 1kHz$	230V _{AC} 120V _{AC}	-	0.96 0.98	-	
T _{SD}	Temperature @ thermal shutdown Thermal hysteresis = 5°C^2		-	85	-	$^\circ\text{C}$

Table 2-4: AC Mains & thermal specifications

Note 1: 100V constant voltage line.

Note 2: 5°C but minimum 10s.

2.5 Auxiliary power supply specification

Electrical Characteristics @ $T_a = 25^\circ\text{C}$ (unless otherwise specified)

Symbol	Parameter	Conditions	Min	Typ	Max	Unit
V _{+7.5V}	+7.5V voltage			7.7		V
V _{+15V}	+15V voltage			15.5		V
V _{-15V}	-15V voltage			-15.5		V
V _{Drive}	Vdrive voltage	Ref. to -85V		12.4		V
I _{+7.5V}	+7.5V current rating ¹		0		800	mA
I _{+15V}	+15V current rating ¹		0		250	mA
I _{-15V}	-15V current rating ¹		-250		0	mA
I _{VDrive}	V _{Drive} current rating ¹		0		170	mA
P _{tot}	Maximum total output power ¹		0		8.3	W

Table 2-5: Auxiliary power supply specification

Note 1: The Auxiliary power supply cannot be loaded with the maximum rated load current for all four outputs simultaneously as this will violate the 8.3W total output power limit. Use the typical Voltage levels from Table 2-5 in combination with the actual load currents to calculate the total power consumption. The calculated total power consumption must comply with the 8.3W total output power limit.

3 Audio measurements

3.1 Frequency response Ch1 and Ch2 (SE)

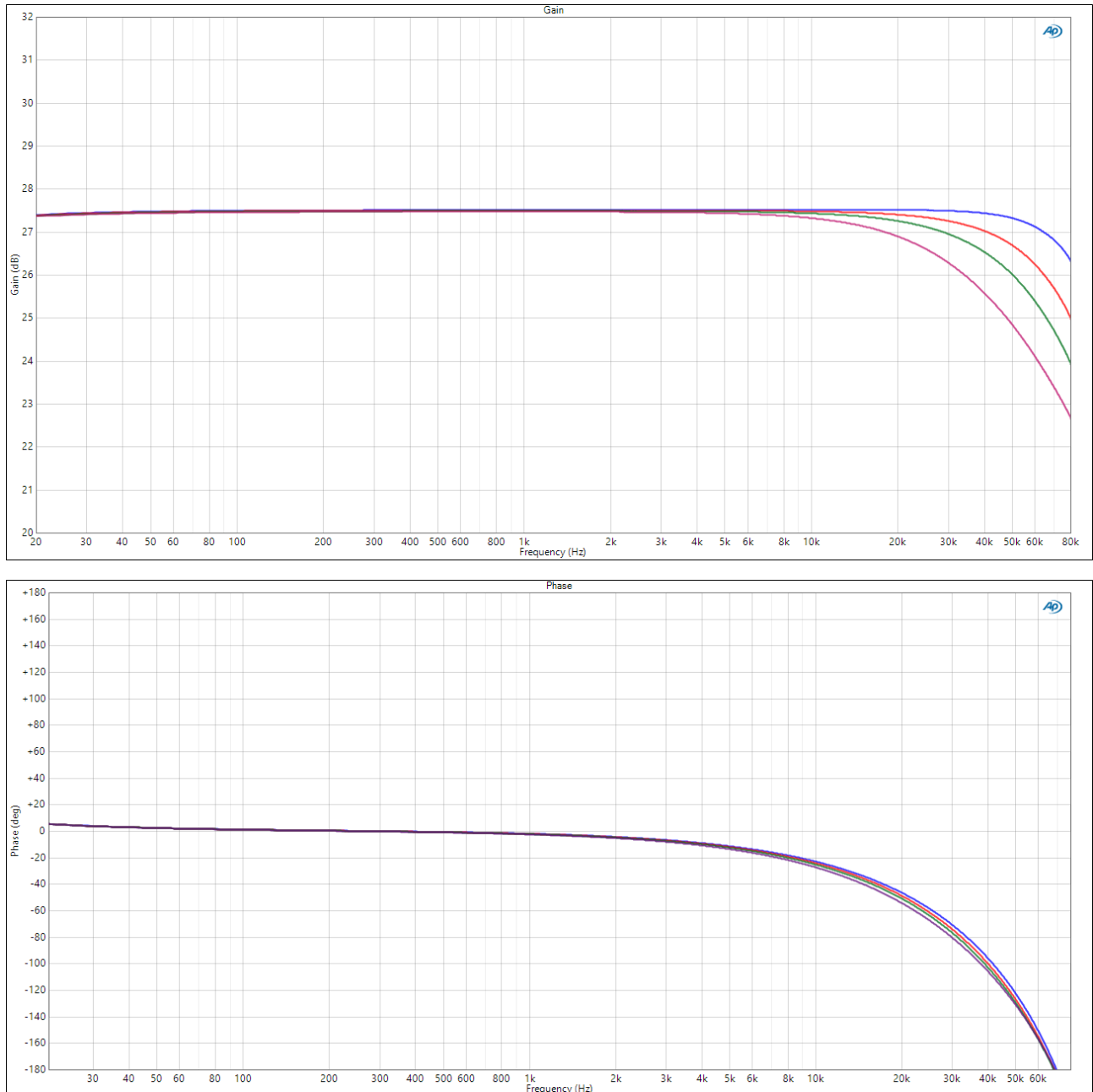

Figure 3-1: Frequency response (Top curves: Amplitude, Bottom curves: Phase)
 2Ω (purple), 4Ω (green), 8Ω (red) and Open Load (blue)

3.2 Frequency response Ch1 - Ch2 (BTL)

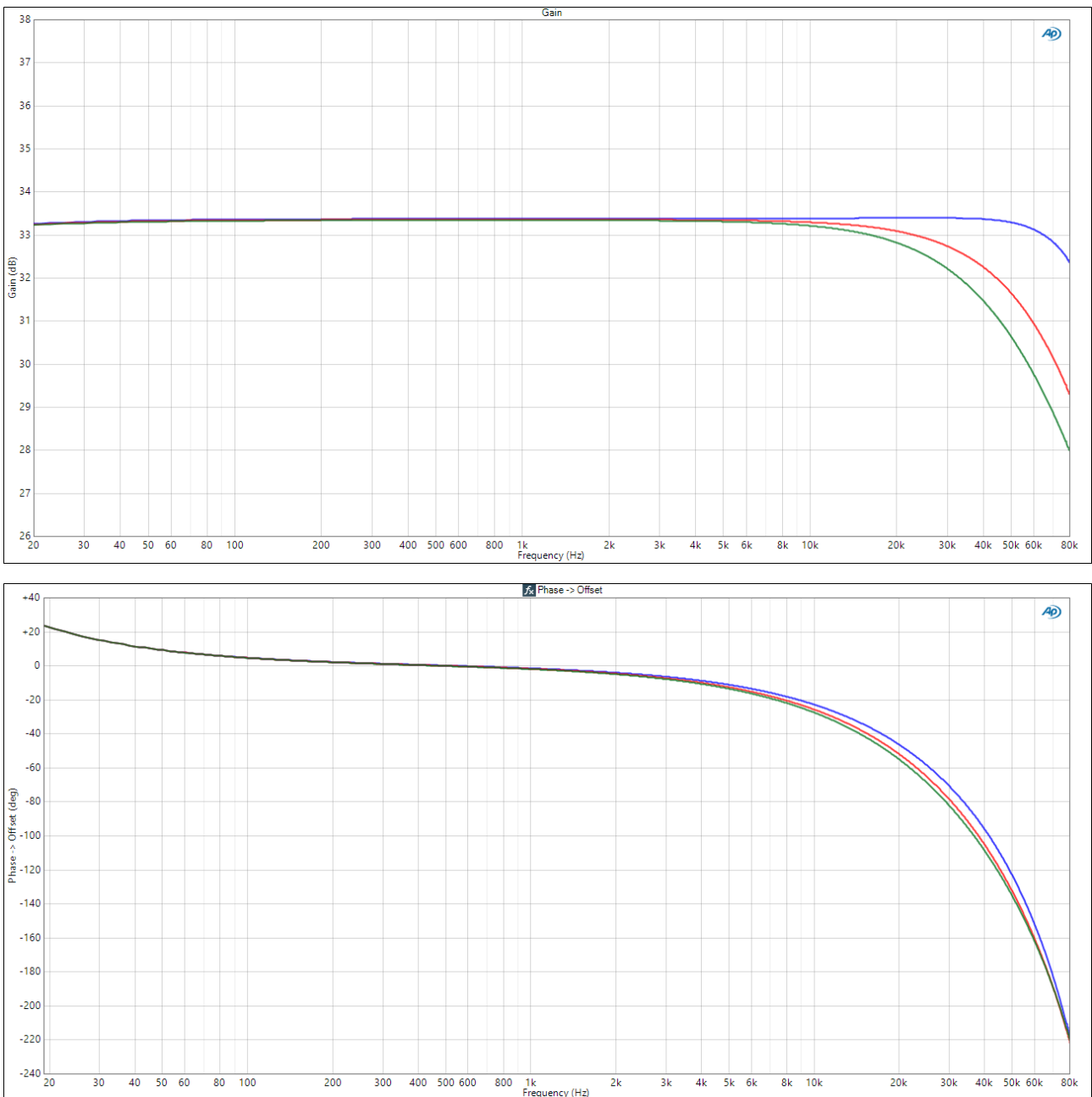

Figure 3-2: Frequency response (op curves: Amplitude, Bottom curves: Phase)
 4Ω (green), 6.67Ω (red) and Open Load (blue)

3.3 Total Harmonic Distortion + Noise (THD+N) Ch1 and Ch2 (SE)

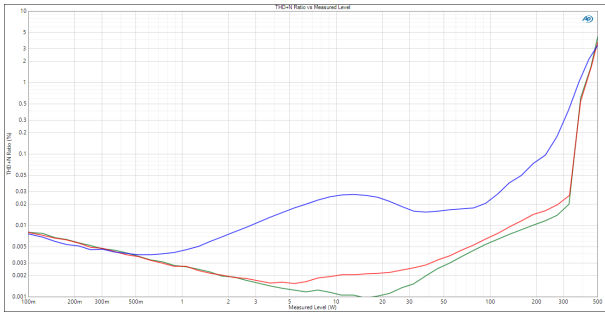

Figure 3-3: THD+N vs. Power @8Ω CH1, 230VAC/120VAC
100Hz (green), 1kHz (red), 6.67kHz (blue)

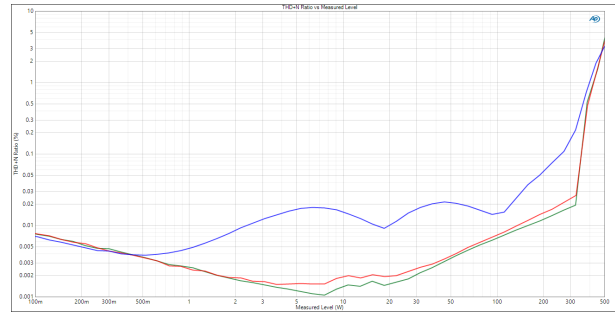

Figure 3-4: THD+N vs. Power @8Ω CH2, 230VAC/120VAC
100Hz (green), 1kHz (red), 6.67kHz (blue)

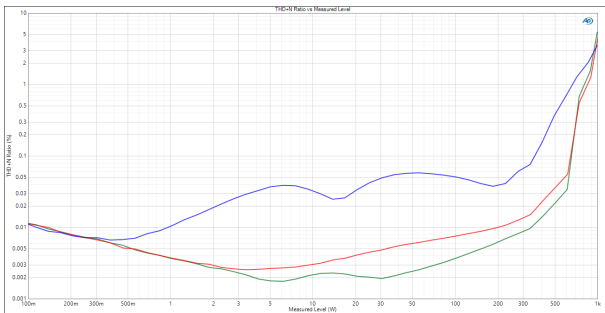

Figure 3-5: THD+N vs. Power @4Ω CH1, 230VAC/120VAC
100Hz (green), 1kHz (red), 6.67kHz (blue)

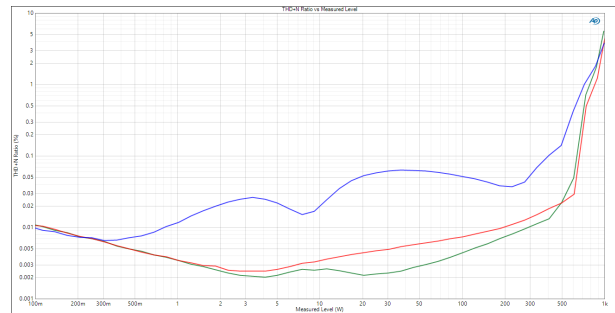

Figure 3-6: THD+N vs. Power @4Ω CH2, 230VAC/120VAC
100Hz (green), 1kHz (red), 6.67kHz (blue)

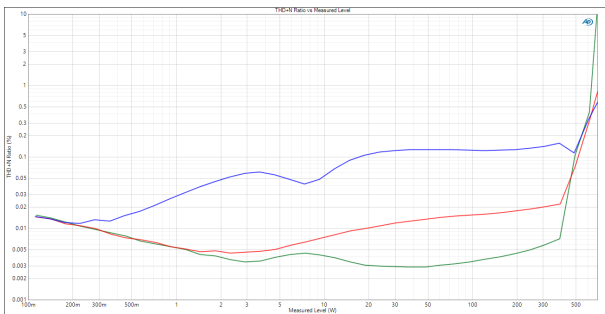

Figure 3-7: THD+N vs. Power @2Ω CH1, 230VAC/120VAC
100Hz (green), 1kHz (red), 6.67kHz (blue)

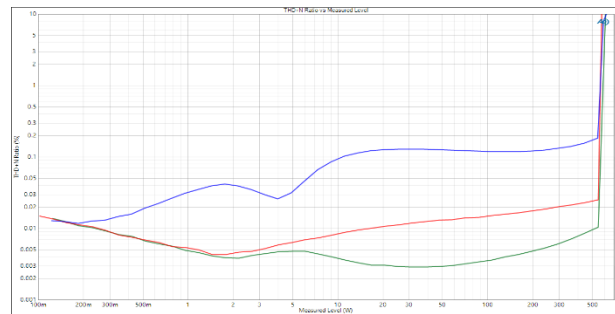

Figure 3-8: THD+N vs. Power @2Ω CH2, 230VAC/120VAC
100Hz (green), 1kHz (red), 6.67kHz (blue)

3.4 Total Harmonic Distortion + Noise (THD+N) Ch1 - Ch2 (BTL)

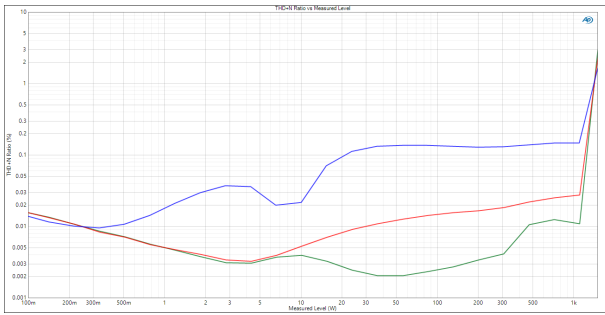

Figure 3-9: THD+N vs. Power @ 4Ω, 230V_{AC}/120V_{AC}
100Hz (green), 1kHz (red), 6.67kHz (blue)

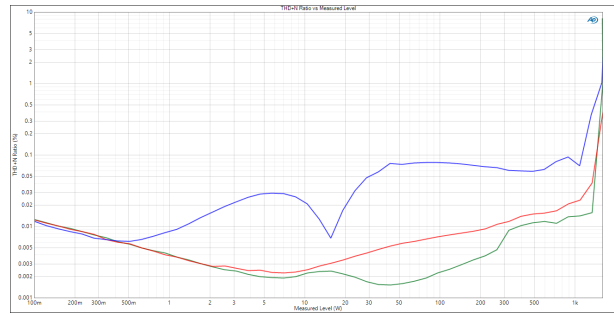

Figure 3-10: THD+N vs. Power @ 6.67Ω, 230V_{AC}/120V_{AC}
100Hz (green), 1kHz (red), 6.67kHz (blue)

3.5 Noise spectrum

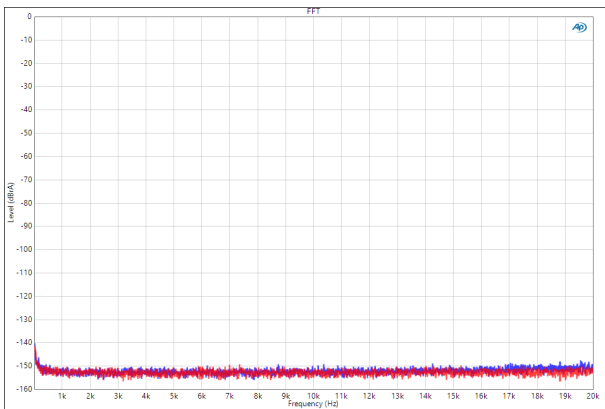

Figure 3-11: FFT idle - (SE) 8 Ω
Channel 1 (blue) & Channel 2 (red)

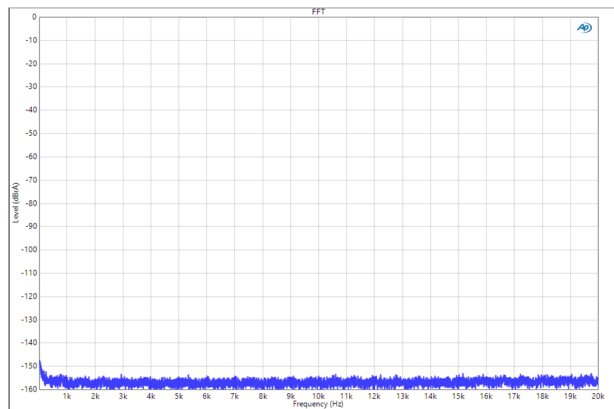

Figure 3-12: FFT idle - (BTL) 6.67 Ω
Channel 1 - Channel 2 (BTL) (blue)

3.6 Intermodulation Distortion (CCIF, TIM) Ch1 and Ch2 (SE)

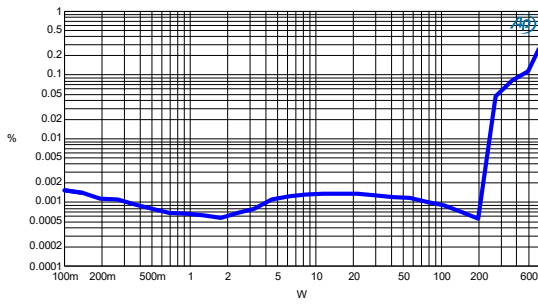

Figure 3-13: CCIF vs. Power - $R_L=4\Omega$
Ch1(LF), $f_1=18\text{kHz}$, $f_2=19\text{kHz}$

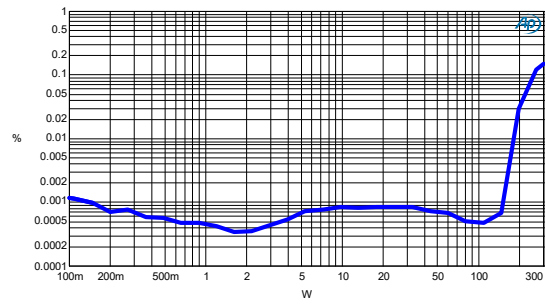

Figure 3-14: CCIF vs. Power - $R_L=8\Omega$
Ch1(LF), $f_1=18\text{kHz}$, $f_2=19\text{kHz}$

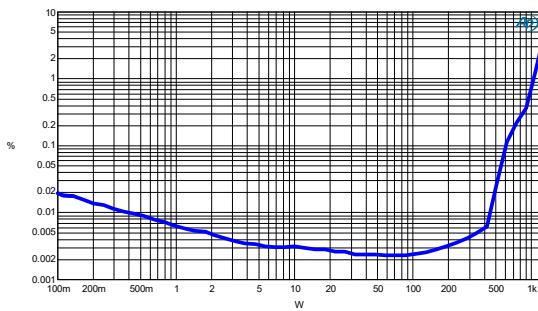

Figure 3-15: TIM vs. Power - $R_L=4\Omega$
Ch1(LF)

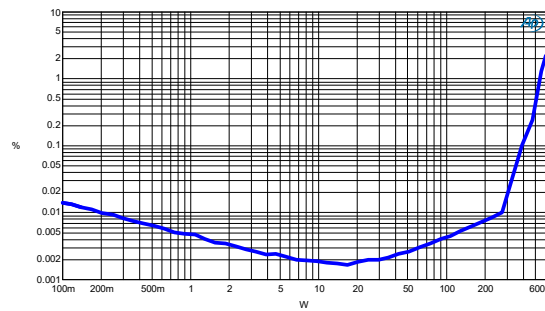

Figure 3-16: TIM vs. Power - $R_L=8\Omega$
Ch1(LF)

3.7 Intermodulation Distortion (CCIF, TIM) Ch1 - Ch2 (BTL)

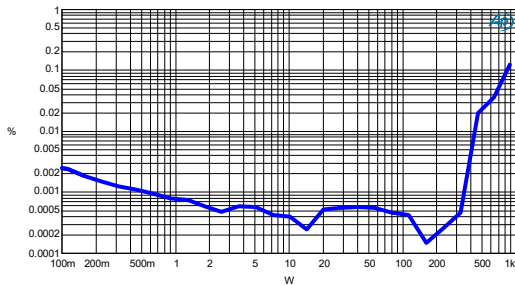

Figure 3-17 CCIF vs. Power - $R_L=4\Omega$
Ch1 - Ch2 (BTL), $f_1=18\text{kHz}$, $f_2=19\text{kHz}$

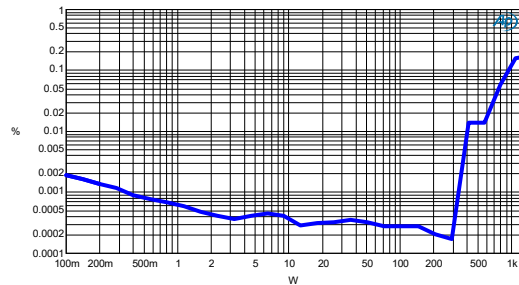

Figure 3-18 CCIF vs. Power - $R_L=6.67\Omega$
Ch1 - Ch2 (BTL), $f_1=18\text{kHz}$, $f_2=19\text{kHz}$

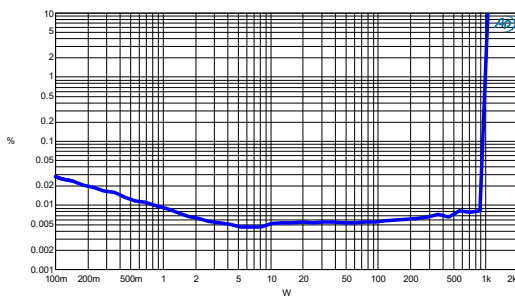

Figure 3-19 TIM vs. Power - $R_L=4\Omega$
Ch1 - Ch2 (BTL)

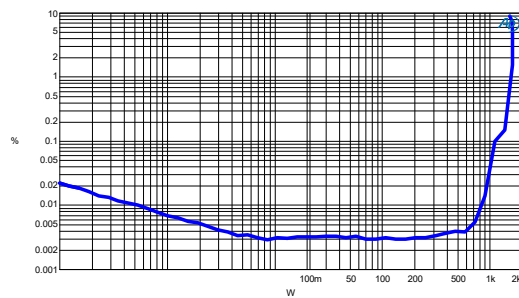

Figure 3-20 TIM vs. Power - $R_L=6.67\Omega$
Ch1 - Ch2 (BTL)

3.8 Output resistance & cross talk

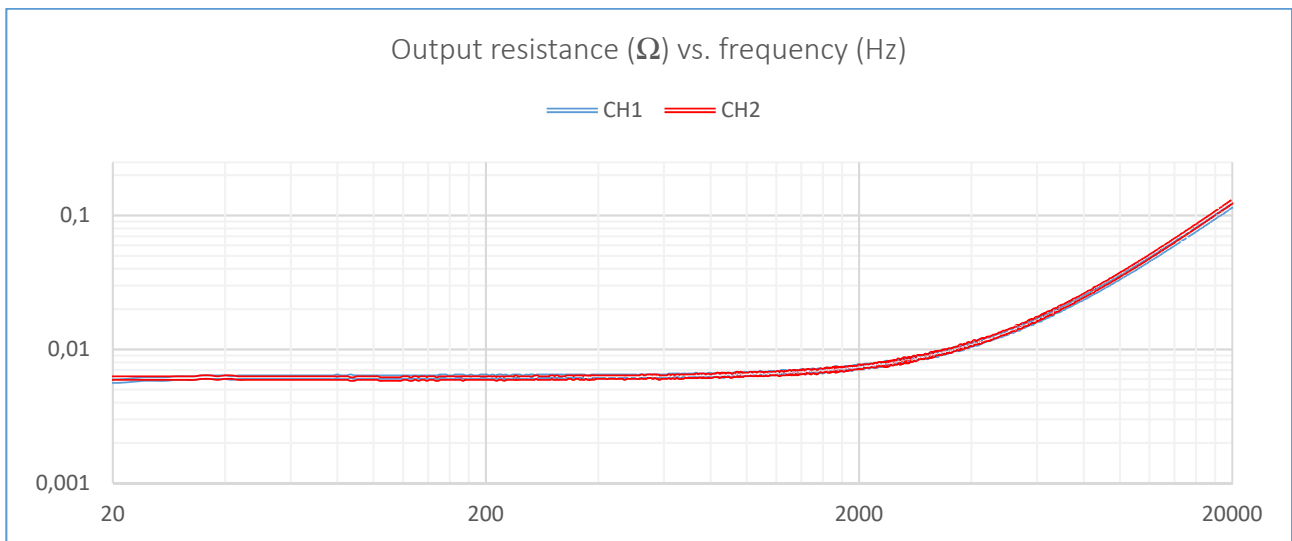

Figure 3-21: Output resistance¹ - Measurement made at the mating part of the output connector. Connector resistance thereby included.

Note 1: Measured using “APx Output Impedance Utility” at the mating part of the output connector, thereby including contact resistance of the connectors.

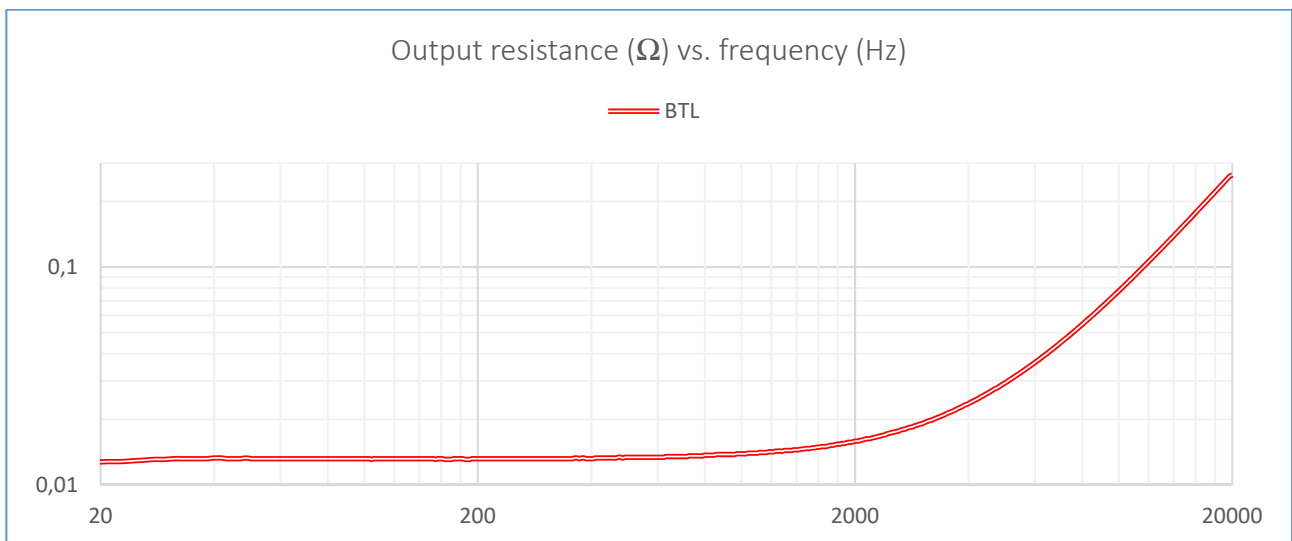

Figure 3-22: Output resistance¹ - Measurement made at the mating part of the output connector. Connector resistance thereby included.

Note 1: Measured using “APx Output Impedance Utility” at the mating part of the output connector, thereby including contact resistance of the connectors.

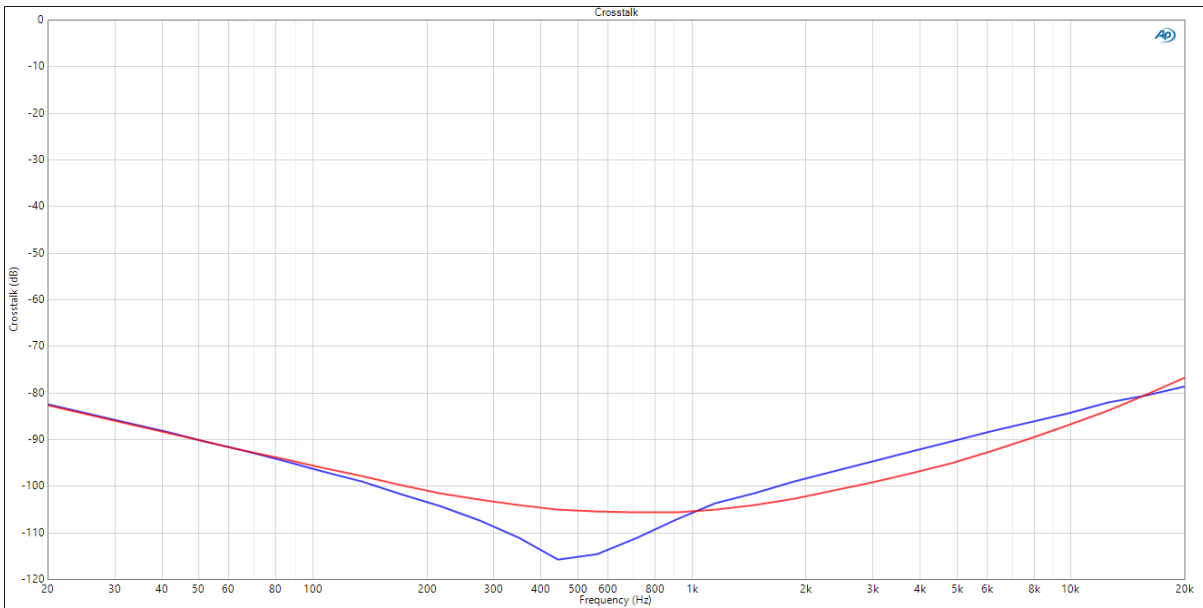

Figure 3-23: Cross talk - Ch.1 @ $P_o, ch2=50W\ 8\Omega$ (blue), Ch.2 @ $P_o, ch1=50W\ 8\Omega$ (red)

3.9 Output voltage vs. frequency

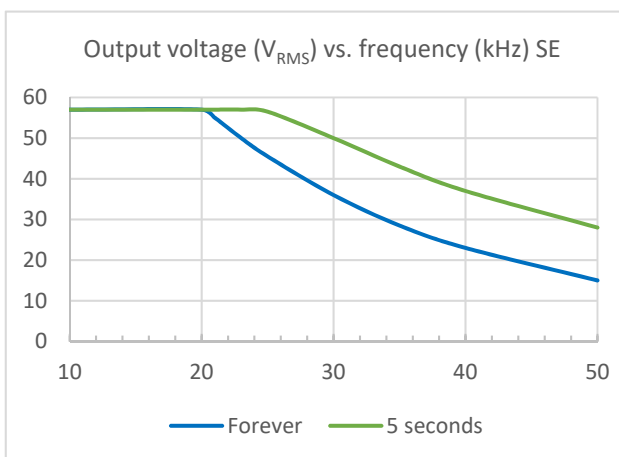

Figure 3-24: Max V_{out} vs. frequency vs. time (SE mode)

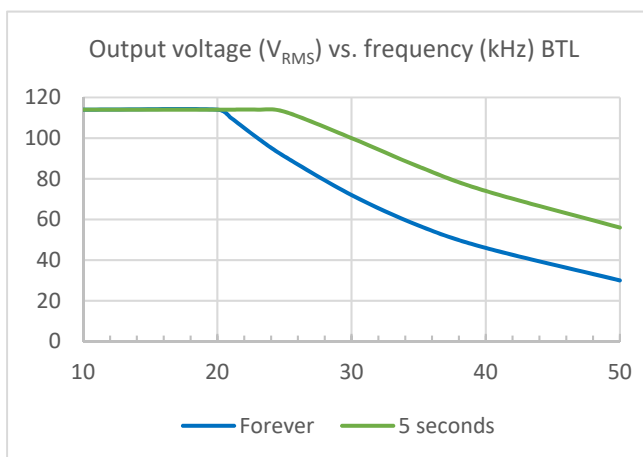

Figure 3-25: Max V_{out} vs. frequency vs. time (BTL mode)

3.10 Efficiency

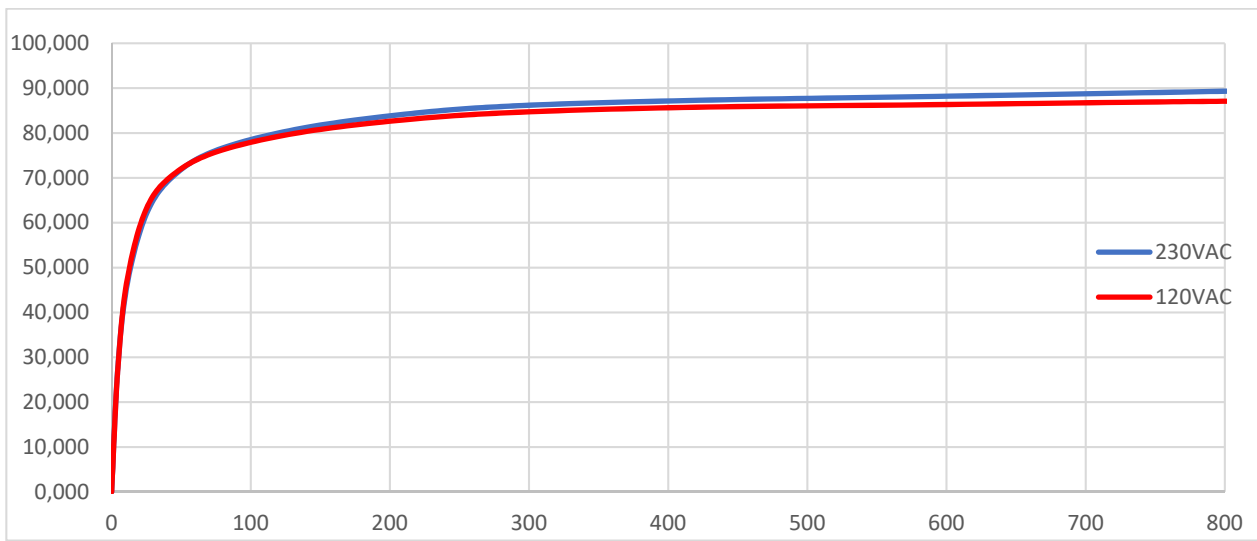

Figure 3-26: Efficiency AC in to AMP out: Ch1 8Ω, Ch2 8Ω

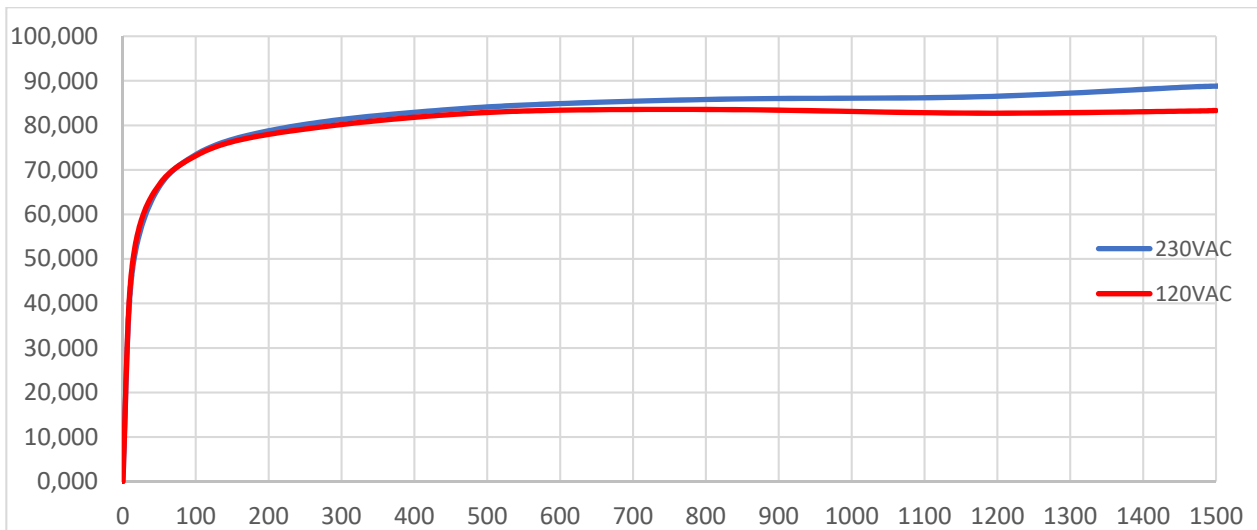

Figure 3-27: Efficiency AC in to AMP out: Ch1 4Ω, Ch2 4Ω

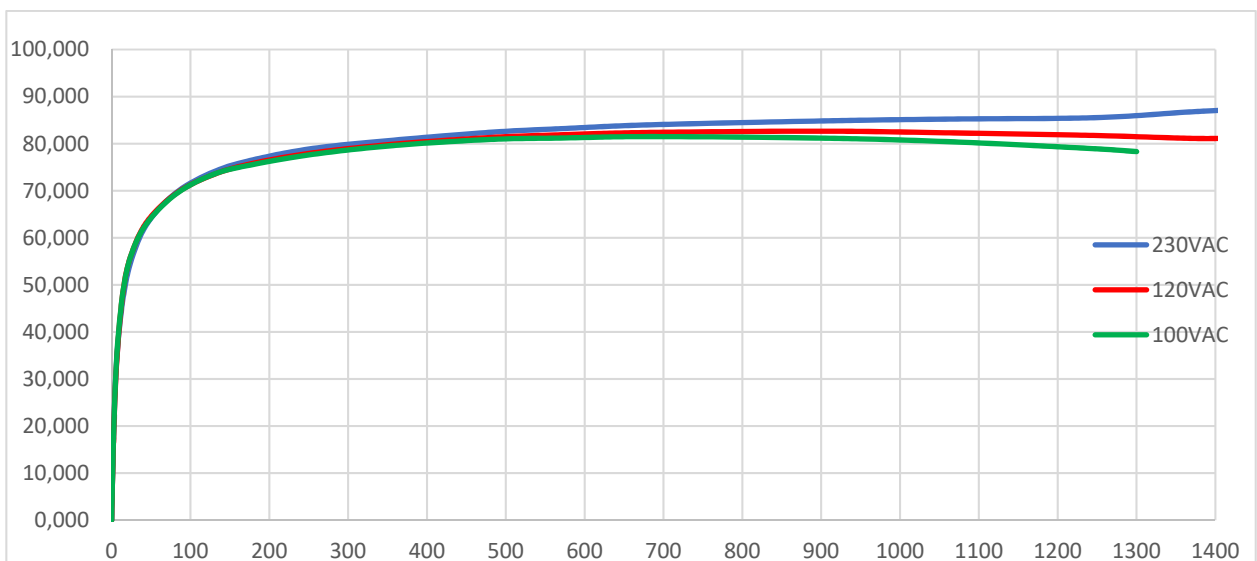

Figure 3-28: Efficiency AC in to AMP out: BTL 6.67Ω

4 Control and readout specification

4.1 Control pins

Mute - When muting the L-PRO2S module, the amplifier outputs will be disabled. It typically takes 0.5ms to disable and only 1ms to enable the amplifier. The mute function may be used with an external wake-on-music circuit, to lower the mains power consumption, when the module is not in use. Even with the wake-on-music functionality used, the module will be ready to play within 1ms (typically).

Standby - With the L-PRO2S module(s) in standby the mains power consumption is put to a minimum. In standby it is possible to comply with the ErP directive (1275/2008/EC) & Energy Star specification with a total power consumption of less than 0.5W. This includes a current draw of up to 25 mA on the +7.5V supply for external standby control circuitry.

Signal_Present - This signal is part of the “Wake on Music” function built into the L-PRO2S modules. If left open the signal is internally pulled high and “Wake on Music” is not used. If pulled low continuously for a selectable amount of time set by the “Signal Time Out Select” the amplifiers will first be muted to save power but are still able to be un-muted within 1ms. If signal present continues to be low, the L-PRO2S series module will enter standby mode. The L-PRO2S series module exits standby mode as soon as the signal present signal is released and being ready within typically 660ms.

A suitable circuit for sensing the audio with a sensitivity of 4mV_{rms} and controlling the Signal_Present pin can be found in the Application Manual covering the L-PRO2S amplifier module.

Signal_TimeOut (L-A2 DC Fault) - This signal is part of the “Wake on Music” function built into the L-PRO2S series modules. Placing a resistor from this pin to GND makes it possible to choose between 3 different timing settings. For details, see the Application Manual covering the L-PRO2S amplifier module.

If a L-A2 module is used together with the L-PRO2S module, then the DC_Fault (pin 15, CON701) on L-A2 must be connected to the Signal TimeOut (pin 14, CON701) on the L-PRO2S module. In case the L-A2 module detects internal DC fault, the open-collector output of the DC_Fault (pin 15, CON701) will be activated thus shorting the Signal TimeOut (pin 14, CON701) of the L-PRO2S to ground.

T-V_Sel/SMPS_OL - This pin can be either an input or an output depending on the selected timing resistor connected to the Signal TimeOut (pin 14, CON701) described above. In the Temp/VAC mode, it will be an input pin - possible to toggle - allowing to read out either the mains voltage or amplifier temperature in real-time. In the Low Rail mode, it is an output pin indicating whether the (+/-85V) rail voltages are below +/-70V, or not. This is useful for a Front End circuit to activate a limiter that prevents the rail voltages from being pulled below the level where sound will disappear temporarily.

4.2 Readout pins

The L-PRO2S Series has various readouts to monitor the state of the module.

Temp/VAC_Out - Amplifier temperature or mains voltage readout; by toggling a control-pin, either mains voltage, or amplifier temperature can be read real-time.

- *Amplifier temperature* - The output stage temperature from 0-100° is expressed as a DC voltage from 0-3.3V. When the module enters thermal protection at 85°C, equivalent to 2.805V, the voltage will jump to 3.3 V indicating thermal protection is active. This makes it possible to both read the live temperature and read when the module is disabled due to thermal protection. The module exits thermal protection when the temperature drops below 80°C and after a minimum of 10s delay has passed - the amplifiers will be re-enabled, and the temperature readout returns to a read out of the actual maximum temperature.
- *Mains voltage* - The AC mains voltage from 85-265V_{AC} is expressed as a DC voltage from 0.213V to 2.925V.

Amplifier Output Voltage readout - There are two amplifier output voltage readouts Vout_Monitor_Ch1 and Vout_Monitor_Ch2, one for each channel. These readouts are voltage divisions of the output signals in the range of ±10 Vp corresponding to ±82Vp at the output.

Amplifier Clip readout - There are two amplifier clip readouts, $\overline{\text{Clip}_1}$ and $\overline{\text{Clip}_2}$. These readouts are open-collector outputs. Each readout pin will be pulled low if the audio output voltage of the corresponding channel becomes too high compared to the internal rail voltages (Voltage Clipping), or if the amplifier reaches internal current protection. This readout may be used for signal clip/limiting indications.

$\overline{\text{Dis_Read/Protect}}$ - This readout is an open-collector output which will be pulled low when the module is either muted or has entered an internal protection.

5 Protection features

The L-PRO2S has built-in protection features to protect the amplifier module against abuse/extreme use scenarios, and to protect the speaker drivers from being damaged in case of a malfunction.

Temperature – Temperature protection of the power supply and amplifiers is implemented to prevent the module from thermal runaway. When thermal protection is engaged both amplifiers are muted until the temperature has dropped 5°C, or for a minimum of 10s.

Over Current – If an amplifier output is shorted or reaches its current limit, the clip readout will be activated to allow an external limiter/DSP to limit the input signal. If the limiter is not capable of limiting the signal, the module will enter over-current protection and mute the amplifier output(s) until the internal protection timing allows the module to re-enable the amplifier(s).

DC Protection – If DC-voltage is detected at one of the amplifier outputs, the L-PRO2S module mutes the outputs. If DC still is present after 3 cycles, the L-PRO2S DC protection circuit switches off the +/-85V power supply. Resetting of the latched protection circuit requires cycling of the AC mains.

If a L-A2 module is used together with the L-PRO2S module, connection of L-PRO2S Signal TimeOut (pin 14, CON701) to the L-A2 DC_Fault (pin 15, CON701) is required to enable DC protection of the L-A2 module.

HF Protection – A high frequency protection is implemented to protect the amplifier output filter components from overload – refer to *Figure 3-24* and *Figure 3-25*. If a high frequency (and high amplitude) signal is present for a longer period, the module will enter HF protection and mute (both) amplifier output(s) until the internal protection timing allows the module to re-enable the amplifier(s).

5.1 L-PRO2S functional blocks

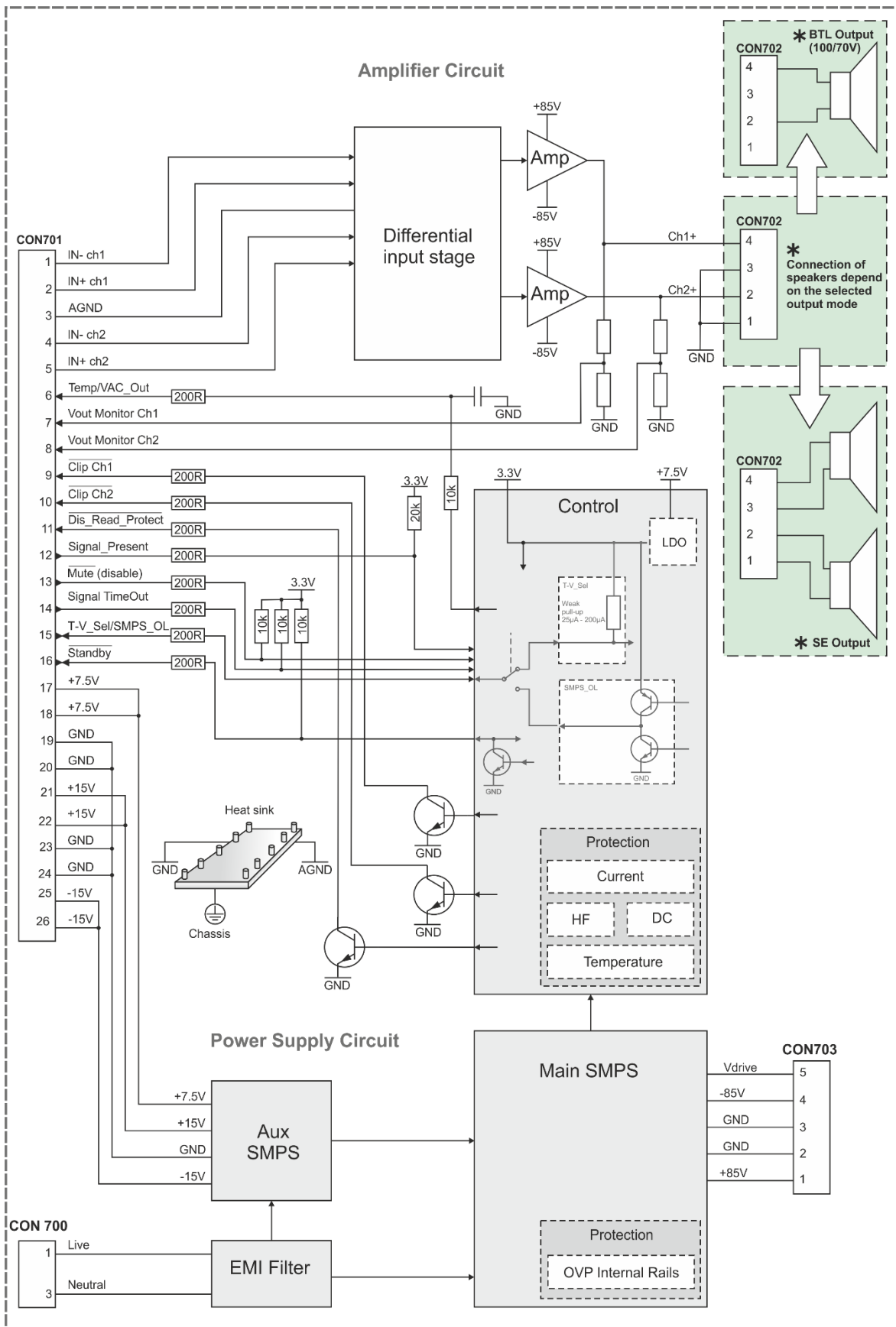

Figure 5-1: Block diagram showing L-PRO2S module functionality.

5.2 L-PRO2S Single Ended (SE) 2 channel 2 – 8 Ohm amplifier

The L-PRO2S Amplifier module consists of two identical (SE) single ended output channels.

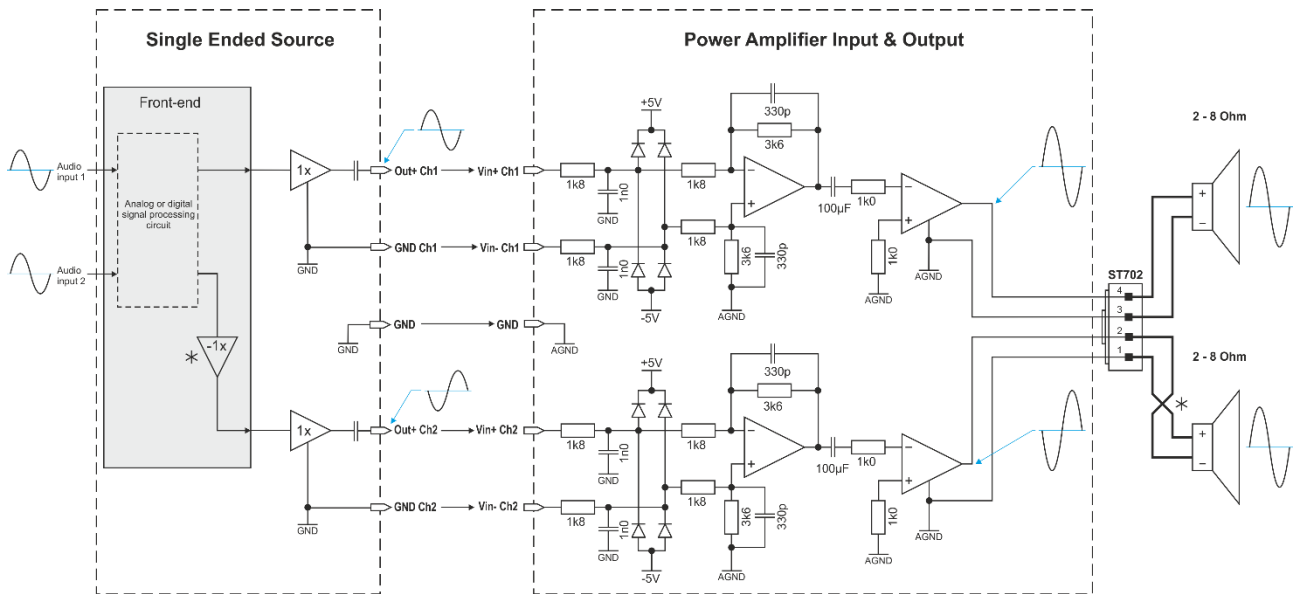

Figure 5-2: L-PRO2S Amplifier module shown in Single Ended (SE) output configuration for 2 – 8 Ohm applications.

NOTICE



The * marking in Figure 5-2, indicates that input and output of channel 2 must be inverted to reduce pumping.

5.3 L-PRO2S Bridge Tied Load (BTL) 4 – 8 Ohm amplifier

Alternatively, the L-PRO2S can be configured in Bridge Tied Load (BTL) mode, as this module contains two identical amplifier channels.

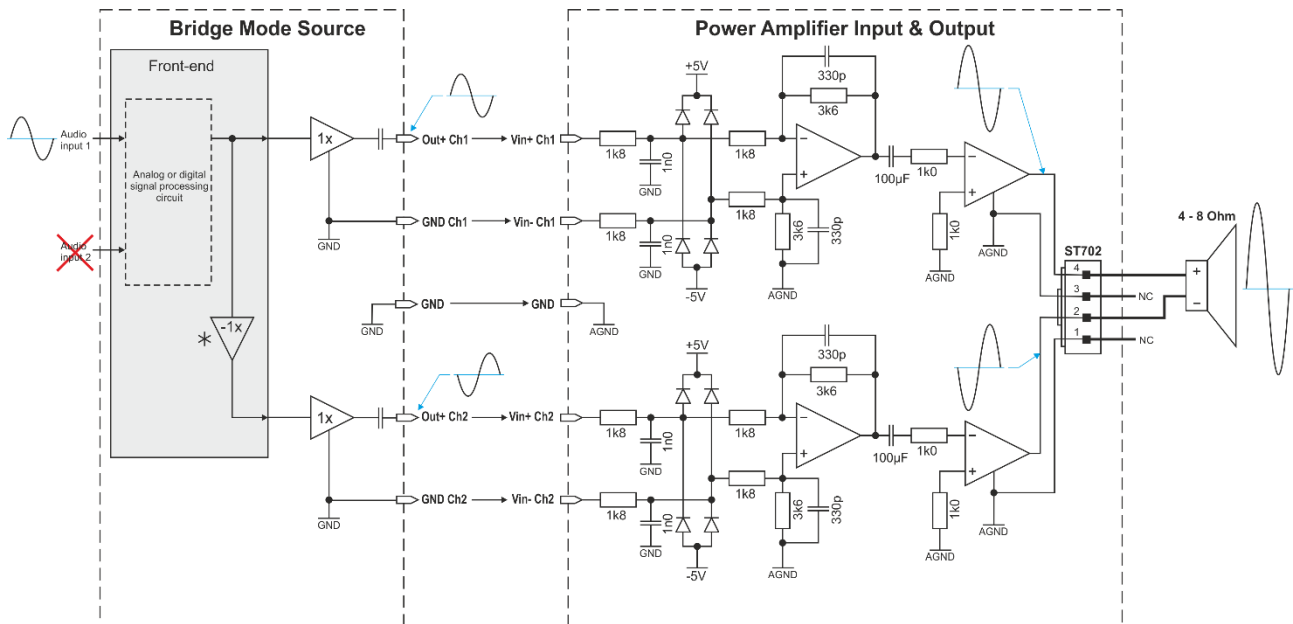

Figure 5-3: L-PRO2S Amplifier module shown in Bridge Tied Load (BTL) output configuration for 4 – 8 Ohm applications.



The * marking in Figure 5-3, indicates that input for channel 2 must be inverted in the Front End to produce the negative swing of the bridge tied output.

5.4 L-PRO2S Bridge Tied Load (BTL) 100/70V Line amplifier

The same Bridge Tied Load (BTL) configuration is suitable for 100/70V Line amplifier applications.

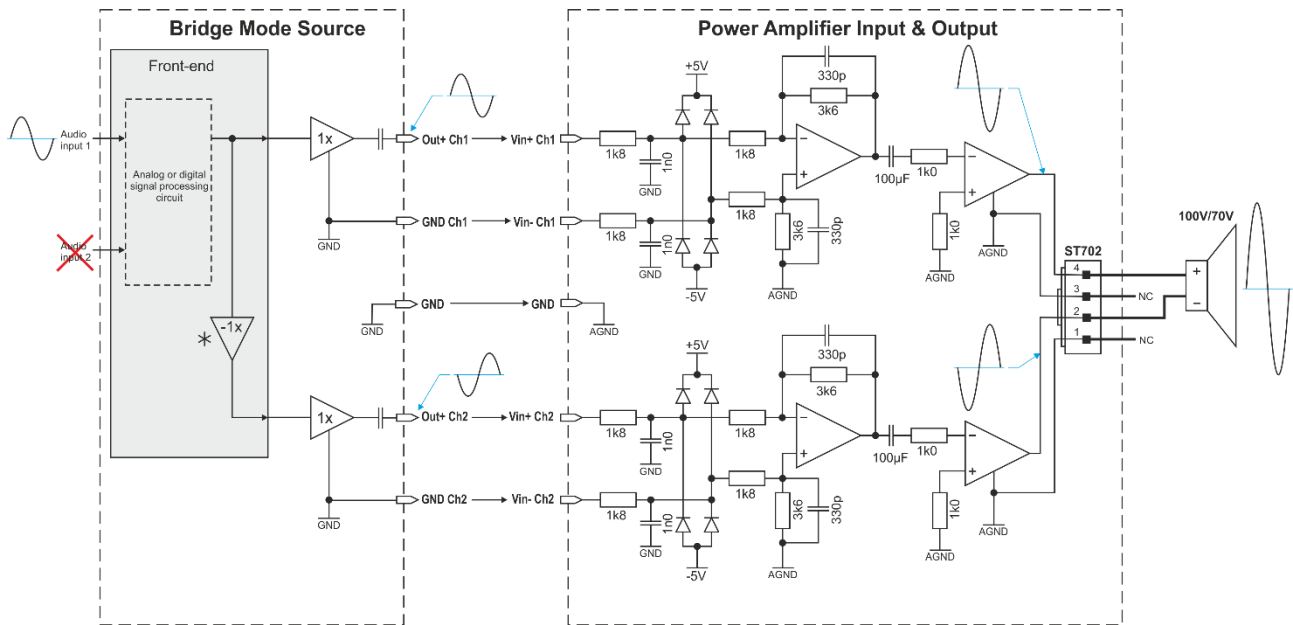

Figure 5-4: L-PRO2S Amplifier module shown in Bridge Tied Load (BTL) output configuration for 100/70V applications.

NOTICE



The * marking in Figure 5-4, indicates that input for channel 2 must be inverted in the Front End to produce the negative swing of the bridge tied output.

6 L-PRO2S connections

This section describes the signal, control, and DC-supply connections for the L-PRO2S modules.

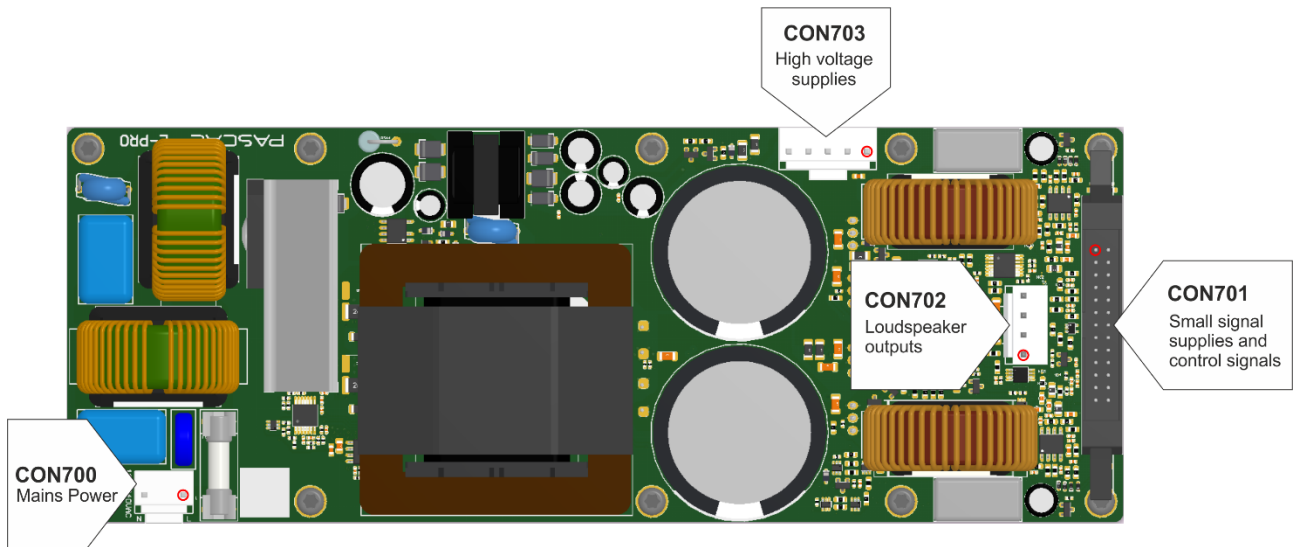

Figure 6-1: L-PRO2S Amplifier module connectors - red circle indicates pin 1

6.1 Mains Power connector

CON700			Description
Name	Pin #	I/O	
L	1	I	The mains input Live/Line wire must be connected to this terminal.
N	2	I	The mains input Neutral wire must be connected to this terminal.

Table 6-1: L-PRO2S Mains connector

6.2 Signal and Control connector

CON701			Description
Name	Pin #	I/O	
Ch1_In-	1	I	Ch 1 (LF) negative signal of the balanced audio input to the L-PRO2S module. The maximum allowable signal on this pin is $\pm 20V_p$.
Ch1_In+	2	I	Ch 1 (LF) positive signal of the balanced audio input to the L-PRO2S module. The maximum allowable signal on this pin is $\pm 20V_p$.
GND	3	-	This pin is a general-purpose GND. Shall be connected to Front End ground plane.
Ch2_In-	4	I	Ch 2 (HF) negative signal of the balanced audio input to the L-PRO2S module. The maximum allowable signal on this pin is $\pm 20V_p$.
Ch2_In+	5	I	Ch 2 (HF) positive signal of the balanced audio input to the L-PRO2S module. The maximum allowable signal on this pin is $\pm 20V_p$.
Temp/Vac_Out	6	O	By default, this pin reads out the highest temperature of the two amplifier channels, or the +/-85V power supply rectifier diodes in the range of 0-3.3V corresponding to 0°C-100°C. The pin will read out 3.3V when in temperature protection. Alternatively, this pin can be used to read out the AC mains voltage from 85-265V _{AC} , expressed as a DC voltage from 0.213V to 2.925V. T-V_Sel/SMPS_OL (pin 15), is used to select either temperature (default), or AC mains readout.
Vout_Monitor_Ch1	7	O	This pin reads out the amplifier channel 1 output voltage. The signal will be in the range $\pm 10V_p$ corresponding to $\pm 82V_p$ on the output of the amplifier. The signal has a high impedance and requires a buffer if used.
Vout_Monitor_Ch2	8	O	This pin reads out the amplifier channel 2 output voltage. The signal will be in the range $\pm 10V_p$ corresponding to $\pm 82V_p$ on the output of the amplifier. The signal has a high impedance and requires a buffer if used.
$\overline{\text{Clip}}_1$	9	O	This pin signals an active low whenever the amplifier Ch1 is voltage clipping or current clipping.
$\overline{\text{Clip}}_2$	10	O	This pin signals an active low whenever the amplifier Ch2 is voltage clipping or current clipping.
$\overline{\text{Dis_Read/Protect}}$	11	O	This pin signals an active low whenever the amplifier channel 1 and channel 2 are disabled or in protection.
Signal_Present	12	-	This signal is part of the "Wake on Music" function built into the L-PRO2S series modules. If left open the signal is internally pulled high and "Wake on Music" is not used. If pulled low continuously for a selectable amount of time set by the "Signal Time Out Select" the amplifier(s) will first mute to save power but still be able to un-mute within 1ms. If the signal present continues to be low the L-PRO2S series module will enter standby mode. The L-PRO2S series module exits standby mode as soon as the Signal_Present pin is released, and the module is ready within typically 660ms.
$\overline{\text{Mute}}$	13	I	An open-collector must be used to actively pull this pin low whenever the module must disable/Mute. When released the module is ready within (typically) 1ms.
Signal_TimeOut	14	I	3 different power safe mode timings can be selected by connecting a resistor of a specified value from the Signal_TimeOut pin to GND. See Table 6-3 for a list of resistor values and corresponding timings. If the Signal Present input is not used the Signal_TimeOut pin can be left unconnected. If the L-A2 module is used together with the L-PRO2S module, then the DC_Fault (pin 15, CON701) on L-A2 must be connected to the Signal TimeOut (pin 14, CON701) on L-PRO2S.

T-V_Sel/SMPS_OL	15	I/O	This pin can be either an input or an output depending on the selected timing resistor connected to Signal_TimeOut (pin 14). If timing resistor T1, T2 or T3 is selected (see Table 6-3) it will be an input pin where it is possible to select either temperature or AC mains readout for the signal Temp/Vac_Mon (pin 6). If pin 15 is left unconnected, the internal pull-up will by default select temperature as the read out on pin 6. If pin 15 is actively pulled low by an open-collector, the mains RMS voltage will be the read out on pin 6. If timing resistor T1(Low Rail), T2(Low Rail) or T3(Low Rail) is selected (see Table 6-3) it will be an output pin that indicates whether the (+/- 85V) the rail voltage is below +/-70V.
Standby	16	I/O	An open-collector must be used to actively pull this pin low whenever the module must enter standby mode. When released the module is ready within a few seconds.
+7.5V	17,18	O	This pin may be used to supply external circuitry.
GND	19,20	-	This pin is the +7.5V ground return.
+15V	21,22	O	This pin may be used to supply external circuitry.
GND	23,24	-	This pin is the ±15V ground return.
-15V	25,26	O	This pin may be used to supply external circuitry.

Table 6-2: L-PRO2S signal and control connector



It is possible to select one of 3 different Mute/Standby timings by connecting a resistor of a specified value between Signal_TimeOut (pin 14) and a GND pin. See Table 6-3 to select a resistor value that corresponds with the standby time you want.

Timing ID	Resistor (Ω)	Mute time	Standby time	T-V_Sel/SMPS_OL function
T1	≥ 150K	2 min	10 min	Input - Temp/VAC selection
T2	100k	10 min	Never enters standby mode	Input - Temp/VAC selection
T3	68k	10 min	25 min	Input - Temp/VAC selection
T1(Low Rail)	47K	2 min	10 min	Output - Low Rail indication
T2(Low Rail)	33K	10 min	Never enters standby mode	Output - Low Rail indication
T3(Low Rail)	24K	10 min	25 min	Output - Low Rail indication
Engineering	7K5	20 seconds	40 seconds	Input - Temp/VAC selection

Table 6-3: Mute/Standby timing and Temp-VAC/Low Rail indication resistor selection

6.3 Speaker Output connector

CON702			Description
Name	Pin #	I/O	
Ch2 Out-	1	O	This pin is used for the GND signal of the channel 2 speaker.
Ch2 Out+	2	O ¹	The amplified speaker signal of channel 2 is available on this pin.
Ch1 Out-	3	O	This pin is used for the GND signal of the channel 1 speaker.
Ch1 Out+	4	O	The amplified speaker signal of channel 1 is available on this pin.

Table 6-4 L-PRO2S speaker connector overview

6.4 DC-Supply connector

CON703			Description
Name	Pin #	I/O	
V _{drive}	1	I	V _{drive} voltage for a Pascal L-A2 Extension Module is available on this pin.
-85V	2	I	Negative rail voltage for L-A2 Extension Module is available on this pin.
GND	3	O	Ground
GND	4	O	Ground
+85V	5	I	Positive rail voltage for a L-A2 Extension Module is available on this pin.

Table 6-5 L-PRO's S-A1/2 Extension Module connector overview

7 Mechanical specifications

This section contains mechanical specifications of the L-PRO2S module.

Item	Min	Typical	Max
(A) Top side components	-	45.00mm	46.50mm
(B) PCB	1.90mm	2.00mm	2.10mm
(C) Bottom side components	4.30mm	4.50mm	4.85mm
(D) Baseplate	2.90mm	3.00mm	3.10mm

Table 7-1: L-PRO2S mechanical specifications

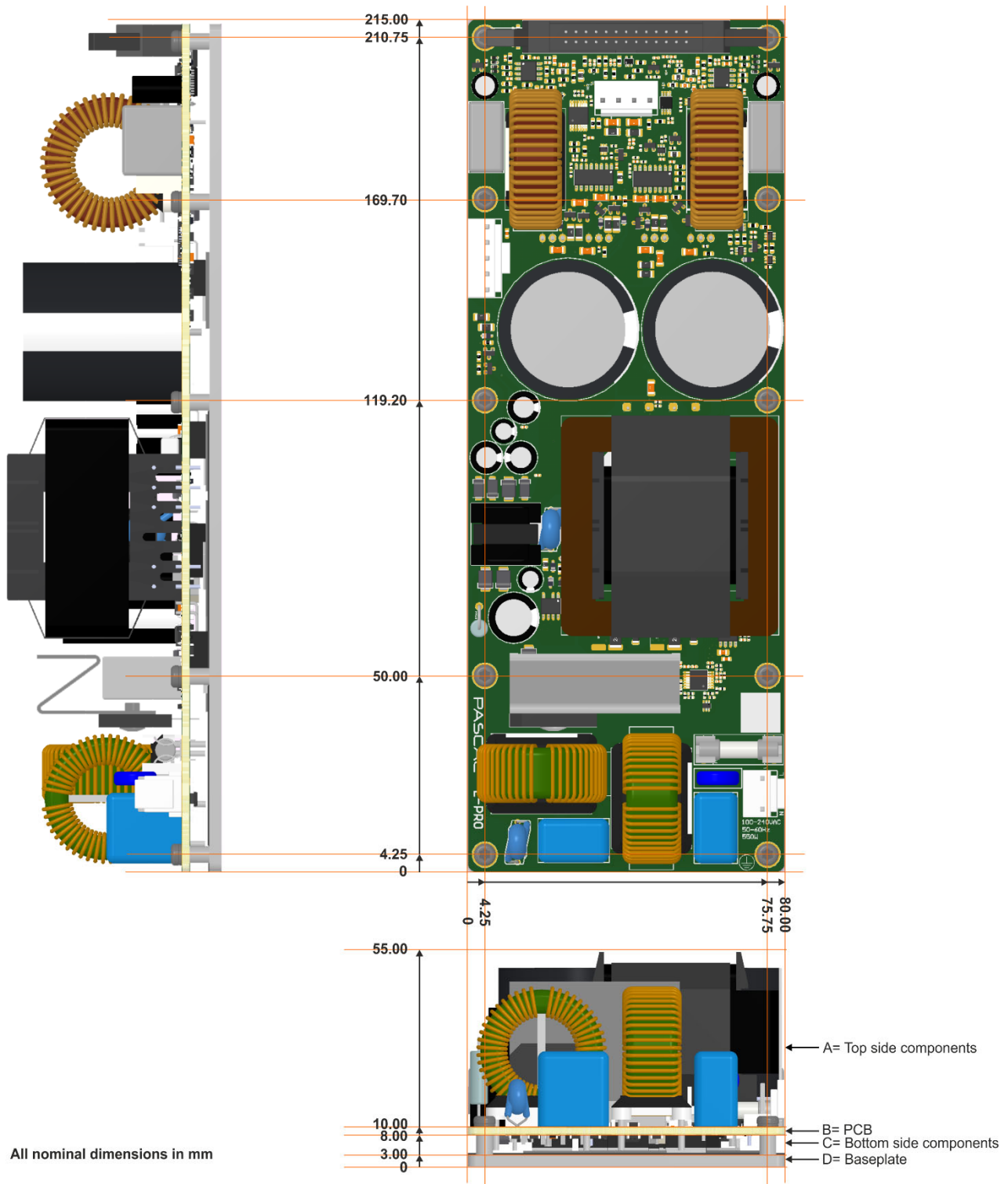

Figure 7-1: Mechanical specifications for L-PRO2S module

8 Regulatory compliance

The L-PRO2 series is designed for fast-track compliance when used in Pro Audio products marketed in EU, North America, and East Asia Region.

Whenever possible the product is pre-certified to save valuable testing time in the end-product. When pre-certification is not possible, extensive testing has been conducted to ensure that the end-product can easily apply for the following marks:

EU	CE Mark
USA + Canada	cULus listing
China	CCC mark
Korea	KC mark
Japan	PSE mark

8.1 Safety compliance

Safety Standards:

The L-PRO2S series is safety tested according to the following standards:

- IEC/EN 60065:2001(7th E) + A1:2005 + A2:2010
- IEC/EN/UL 62368-1:2014 (2nd E)

The L-PRO2S series fulfills the requirements of:

- EN 60065:2002 + A1:2006 + A11:2008 + A2:2010 + A12:2011
- EN 62368-1:2014
- CSA C22.2 NO. 62368-1-14:2014
- UL 62368:2014

The L-PRO2S series is evaluated against and complies with the regulations of the following countries:

60065	AR, AT, AU, BE, BY, CA, CH, CN, CZ, DE, DK, ES, EU, FI, FR, GB, GR, HU, IE, IT, JP, KR, MY, NL, NO, NZ, PL, PT, RO, SE, SG, SI, SK, UA, US
62368-1	CA, DK, FI, DE, IE, IT, NO, SE, GB, US, CENELEC common modifications

(Countries outside the CB Scheme membership may also accept the reports.)

Test procedure:

60065	L-PRO2S CB certificate no. E470499-A7 (UL International Demko A/S)
62368-1	L-PRO2S CB certificate no. E470499-A6005 (UL International Demko A/S)
	UL recognized under file no. E470499

(Full reports are available for download on Pascal Extranet)

Product safety category:

Class I (*Earthed equipment*)

Special Notice:

The L-PRO2S series are tested as components – the final product should always be evaluated against applicable standards.

8.2 Electro Magnetic Compliance

Pascal amplifier modules are EMI compliance tested according to the following standards:

Emission:

EN 55032:2012 with EN 55032:2012 AC 2013
EN 61000-3-2:2014
EN 61000-3-3:2013

FCC part 15 subpart B

Immunity:

EN 55103-2:2009
EN 55035:2017

Special Notice:

EMI verification measurements of the final product should be carried out to secure compliance of the final product.

8.3 ESD precautions

To retain the right to Pascal warranty on products, precautions on ESD must be taken when handling Pascal products. Handling of Pascal products should comply with the following standards:

IEC 61340-5-2: Protection of electronic devices from electrostatic phenomena. User Guide.
IEC 61340-5-1: Protection of electronic devices from electrostatic phenomena. General. Requirements.

ANSI/ESD-S20.20: Protection of Electrical and Electronic Parts, Assemblies, and Equipment.

8.4 Changes

Pascal Products are continuously undergoing smaller changes to improve the performance or to comply with manufacturing and quality requirements. Therefore, specifications in this data sheet are subject to change.

8.5 CE marking

See *EC Declaration of Conformity*, available from www.pascal-audio.com/extranet

For further information:

www.pascal-audio.com

Or contact us at:

Info@pascal-audio.com
Phone: +45 3699 1944

Pascal A/S
Ellekaer 6
2730 Herlev
Denmark